



CONTINENTAL
FIREPLACES & HVAC

Owner's Manual

Original Instructions

heat pump

DC Inverter U-match Series for R410A Unitary Split Heat Pump

Models:

Outdoor Unit

CS18HV24A36

CS18HV48A60

Thank you for choosing commercial air conditioners.
Please read this Owner's manual carefully before operation
and retain it for future reference.

To Users

Thank you for selecting our product. Please read this instruction manual carefully before installing and using the product, so as to master and correctly use the product. In order to guide you to correctly install and use our product and achieve expected operating effect, we hereby instruct as below:

- (1) This appliance can be used by children aged from 8 years and above and persons with reduced physical, sensory or mental capabilities or lack of experience and knowledge if they have been given supervision or instruction concerning use of the appliance in a safe way and understand the hazards involved. Children shall not play with the appliance. Cleaning and user maintenance shall not be made by children without supervision.
- (2) In order to ensure reliability of product, the product may consume some power under stand-by status for maintaining normal communication of system and preheating refrigerant and lubricant. If the product is not to be used for long, cut off the power supply; please energize and preheat the unit in advance before reusing it.
- (3) Please properly select the model according to actual using environment, otherwise it may impact the using convenience.
- (4) This product can't be installed at corrosive, inflammable or explosive environment or the place with special requirements, such as kitchen. Otherwise, it will affect the normal operation or shorten the service life of the unit, or even cause fire hazard or serious injury. As for above special places, please adopt special air conditioner with anti-corrosive or anti-explosion function.
- (5) If the product needs to be installed, moved or maintained, please contact our designated dealer or local service center for professional support. Users should not disassemble or maintain the unit by themselves, otherwise it may cause relative damage, and our company will bear no responsibilities.
- (6) All the illustrations and information in the instruction manual are only for reference. In order to make the product better, we will continuously conduct improvement and innovation. If there is adjustment in the product, please subject to actual product.

Exception Clauses

Manufacturer will bear no responsibilities when personal injury or property loss is caused by the following reasons:

- (1) Damage the product due to improper use or misuse of the product.
- (2) Alter, change, maintain or use the product with other equipment without abiding by the instruction manual of manufacturer.
- (3) After verification, the defect of product is directly caused by corrosive gas.
- (4) After verification, defects are due to improper operation during transportation of product.
- (5) Operate, repair, maintain the unit without abiding by instruction manual or related regulations.
- (6) After verification, the problem or dispute is caused by the quality specification or performance of parts and components that produced by other manufacturers.
- (7) The damage is caused by natural calamities, bad using environment or force majeure.

Contents

1 Safety Precautions	1
2 Product Introduction	5
2.1 Operating Range.....	5
2.2 Standard Accessories.....	5
2.3 Optional Accessories.....	5
2.4 Functions.....	5
3 Installation.....	7
3.1 Installation Preparation	7
3.2 Unit Installation	13
3.3 Electrical Installation	20
3.4 Check after Installation.....	25
3.5 Test Running.....	26
4 Maintenance.....	27
4.1 Failures Not Caused by Faults of The AC	27
4.2 Error Code	29
4.3 Unit Maintenance	30
4.4 Notice on Maintenance	31
4.5 After-Sales Services.....	36

This marking indicates that this product should not be disposed with other household wastes throughout the EU. To prevent possible harm to the environment or human health from uncontrolled waste disposal, recycle it responsibly to promote the sustainable reuse of material resources. To return your used device, please use the return and collection systems or contact the retailer where the product was purchased. They can take this product for environmental safe recycling.



1 Safety Precautions

WARNING

This product can't be installed at corrosive, inflammable or explosive environment or the place with special requirements, such as kitchen. Otherwise, it will affect the normal operation or shorten the service life of the unit, or even cause fire hazard or serious injury. As for above special places, please adopt special air conditioner with anti-corrosive or anti-explosion function.

Improper installation, adjustment, alteration, service, maintenance, or use can cause explosion, fire, electrical shock, or other conditions which may cause death, personal injury, or property damage. Consult a qualified installer, service agency, or your distributor or branch for information or assistance. The qualified installer or agency must use factory--authorized kits or accessories when modifying this product. Refer to the individual instructions packaged with the kits or accessories when installing. Follow all safety codes. Wear safety glasses, protective clothing, and work gloves. Use quenching cloth for brazing operations. Have fire extinguisher available. Read these instructions thoroughly and follow all warnings or cautions included in literature and attached to the unit. Consult local building codes and National Electrical Code (NEC) for special requirements. Recognize safety information. This is the safety--alert symbol .

When you see this symbol on the unit and in instructions or manuals, be alert to the potential for personal injury. Understand these signal words: **DANGER**, **WARNING**, **CAUTION** and **NOTICE**. These words are used with the safety--alert symbol.

 **DANGER** Indicates a hazardous situation that, if not avoided, will result in death or serious injury.

 **WARNING** Indicates a hazardous situation that, if not avoided, could result in death or serious injury.

 **CAUTION** Indicates a hazardous situation that, if not avoided, may result in minor or moderate injury.

NOTICE Indicates important but not hazard-related information, used to indicate risk of property damage.

WARNING

Electrical shock hazard:

Failure to follow this warning could result in personal injury or death.

Before installing, modifying, or servicing system, main electrical disconnect switch must be in the OFF position. There may be more than 1 disconnect switch. Lock out and tag switch with a suitable warning label.

WARNING

- (1) The air conditioner should be grounded to avoid electric shock. Do not connect the ground wire to gas pipe, water pipe, lightning arrester or telephone wire.
- (2) The appliance shall be stored in a well-ventilated area where the room size corresponds to the room area as specified for operation.
- (3) The appliance shall be stored in a room without continuously operating open flames (for example an operating gas appliance) and ignition sources (for example an operating electric heater).
- (4) According to federal/state/local laws and regulations, all packages and transportation materials, including nails, metal or wooden parts, and plastic packing material, must be treated in a safe way.

WARNING

- (1) Please install according to this instruction manual. Installation must be performed in accordance with the requirement of NEC and CEC by authorized personnel only.
- (2) Any person who is involved with working on or breaking into a refrigerant circuit should hold a current valid certificate from an industry-accredited assessment authority, which authorises their competence to handle refrigerants safely in accordance with an industry recognised assessment specification.
- (3) Servicing shall only be performed as recommended by the equipment manufacturer.
- (4) The appliance shall be installed in accordance with national wiring regulations.
- (5) The fixed wires connecting to the appliance must be configured with all-pole disconnection device under voltage grade III according to wiring rules.
- (6) Air conditioner should be stored with protective measures against mechanical damage caused by accident.
- (7) If the installation space for air conditioner pipe is too small, adopt a protective measure to prevent the pipe from physical damage.

⚠ WARNING

- (8) During installation, use the specialized accessories and components, otherwise water leakage, electric shock or fire hazard may occur.
- (9) Please install the air conditioner in a secure place that can withstand the weight of air conditioner. Insecure installation may cause the air conditioner falling down and lead to injury.
- (10) Be sure to adopt independent power circuit. If the power cord is damaged, it must be repaired by the manufacturer, service agent or other professional agents.
- (11) The air conditioner can be cleaned only after it is turned off and power-disconnected, otherwise electric shock may occur.
- (12) The air conditioner is not intended to be cleaned or maintained by children without supervision.
- (13) Do not alter the setting of pressure sensor or other protective devices. If the protective devices are short-circuited or changed against rules, fire hazard or even explosion may occur.
- (14) Do not operate the air conditioner with wet hands. Do not wash or sprinkle water on the air conditioner, otherwise malfunction or electric shock will occur.
- (15) Do not dry the filter with naked flame or an air blower; otherwise the filter will be out of shape.
- (16) If the unit is to be installed in a small space, please adopt protective measures to prevent the concentration of refrigerant from exceeding the allowable safety limit; excessive refrigerant leakage may lead to explosion.
- (17) When installing or re-installing the air conditioner, please keep the refrigerant circuit away from substances other than the specified refrigerant, such as air. Any presence of foreign substances will cause abnormal pressure change or even explosion, resulting in injury.

NOTICE

- (1) Do not put a finger or other objects into the air inlet or return air grill.
- (2) Please adopt safety protection measures before touching the refrigerant pipe; otherwise your hands may be hurt.
- (3) Please arrange the drain pipe according to the instruction manual.
- (4) Never stop the air conditioner by directly cutting off the power.
- (5) Please select the proper copper pipe according to the requirement for pipe thickness.

NOTICE

- (6) Never install the air conditioner in the following places:
 - a) Places with oil smoke or volatile liquid: plastic parts may deteriorate and fall off or even cause water leakage.
 - b) Places with corrosive gas: copper pipe or the welding parts may be corroded and cause refrigerant leakage.
- (7) Adopt proper measures to protect the outdoor unit from small animals because they may damage the electric components and cause malfunction of the air conditioner.

NOTICE



- (1) If thermostat is to be used, it should be connected first before powering up the unit, otherwise the thermostat may not be able to use.
- (2) Only use soft dry cloth or slightly wet cloth with neutral detergent to clean the casing of the air conditioner.
- (3) Before operating the unit under low temperature, connect it to power for 8 hours. If it is stopped for a short time, for example, one night, do not cut off the power (This is to protect the compressor).

2 Product Introduction

2.1 Operating Range

—	Cooling	Heating
Outdoor temperature	5°F(-15°C)~129.2°F (54°C)	-22°F (-30°C)~75.2°F (24°C)

2.2 Standard Accessories

Outdoor unit accessories				
No.	Name	Appearance	Q'ty	Usage
1	Drain plug		3	To plug the unused drain hole
2	Drainage connector	 or 	1	To connect with the hard PVC drain pipe

2.3 Optional Accessories

If utilizing a brazed connection, it is recommended to use a bi-directional filter drier in the refrigerant line (to be purchased separately from a local distributor).

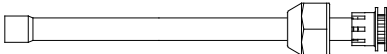

Outdoor unit accessories				
No.	Name	Appearance	Q'ty	Usage
1	Throw-over pipe		1	Connect the unit with the liquid pipe
2	Throw-over pipe		1	Connect the unit with the gas pipe

2.4 Functions

Note: white box indicates dip position.

2.4.1 Set Capacity Dip Switch

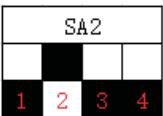
Set the capacity of the outdoor unit through the four dip switches of the outdoor unit main control board. Specific dip switch definition, the first dip switch distinguishes the capacity.

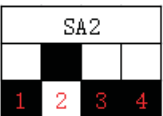
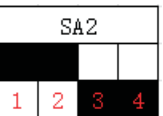
Capacity	24K	36K	48K	60K
Dip Switches				

2.4.2 Set Defrost Mode

The second dip switch is selecting the defrost mode.

The second dip switch is used to change the defrost setting, factory default setting is standard defrost. Under extremely low environment temperature, if the standard defrost cannot have the condenser defrosted completely, please set the second dip switch to be strong defrost. Under strong defrost, the defrosting time will be longer, which enable the condenser to be defrosted completely.

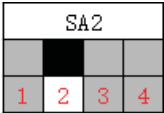
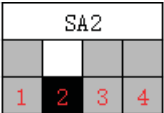
Defrost mode	Outdoor unit dip switches
Standard Defrost (Default)	
Strong Defrost	

2.4.3 Set Operating Mode

The third dip switch and the fourth dip switch are selecting the operating mode. Standard mode is the conventional mode.

By setting the strong mode dip switches of the condensing unit, the air conditioner can quickly increase the capacity output and ensure reliable operation in a short time, so as to meet the user's demand for the indoor temperature to quickly reach the set temperature.

Energy saving mode is achieved by setting the condensing unit operating mode to operate the air conditioner within a small load range.

Operating mode	Outdoor unit dip switches												
Standard mode (Default)	<table border="1" style="margin-left: auto; margin-right: auto;"> <tr><td colspan="4" style="text-align: center;">SA2</td></tr> <tr><td style="background-color: #cccccc;"></td><td style="background-color: #cccccc;"></td><td style="background-color: #cccccc;"></td><td style="background-color: #cccccc;"></td></tr> <tr><td style="color: red; text-align: center;">1</td><td style="color: red; text-align: center;">2</td><td style="color: red; text-align: center;">3</td><td style="color: red; text-align: center;">4</td></tr> </table>	SA2								1	2	3	4
SA2													
1	2	3	4										
Strong mode	<table border="1" style="margin-left: auto; margin-right: auto;"> <tr><td colspan="4" style="text-align: center;">SA2</td></tr> <tr><td style="background-color: #cccccc;"></td><td style="background-color: #cccccc;"></td><td style="background-color: black;"></td><td style="background-color: #cccccc;"></td></tr> <tr><td style="color: red; text-align: center;">1</td><td style="color: red; text-align: center;">2</td><td style="color: red; text-align: center;">3</td><td style="color: red; text-align: center;">4</td></tr> </table>	SA2								1	2	3	4
SA2													
1	2	3	4										
Energy saving mode	<table border="1" style="margin-left: auto; margin-right: auto;"> <tr><td colspan="4" style="text-align: center;">SA2</td></tr> <tr><td style="background-color: #cccccc;"></td><td style="background-color: #cccccc;"></td><td style="background-color: #cccccc;"></td><td style="background-color: black;"></td></tr> <tr><td style="color: red; text-align: center;">1</td><td style="color: red; text-align: center;">2</td><td style="color: red; text-align: center;">3</td><td style="color: red; text-align: center;">4</td></tr> </table>	SA2								1	2	3	4
SA2													
1	2	3	4										

3 Installation

3.1 Installation Preparation

3.1.1 Selection of Installation Location

 WARNING
①. The unit must be installed where strong enough to withstand the weight of the unit and fixed securely, otherwise the unit would topple or fall off.
②. Install the air conditioner at a place where the inclination is less than 5°.
③. Do not install where there is the danger of combustible gas leakage.
④. Do not install the unit at a place with leakage of inflammable gas.

Selection of installation location for outdoor unit (Select a location pursuant to the following condition).

- (1) Noise and air flow produced by the outdoor unit will not disturb the neighbors.
- (2) Select a location that is safe and away from animals and plants. If not, please add safety fences to protect the unit.
- (3) Install at a place with good ventilation. Make sure the outdoor unit stays at a well-ventilated place with no obstacles nearby that may obstruct the air inlet and outlet.
- (4) The installation location should be able to withstand the weight and vibration of outdoor unit and allow the installation to be carried out safely.
- (5) Avoid installing at a place with leakage of inflammable gas, oil smoke or corrosive gas.
- (6) Keep it away from strong wind because strong wind will affect the outdoor fan and lead to insufficient air flow volume and thus affecting the unit's performance.
- (7) Away from any object that may get the air conditioner generating noise.
- (8) Install the outdoor unit at a place where condensate can be easily drained.

3.1.2 Unit Dimension

CS18HV24A36

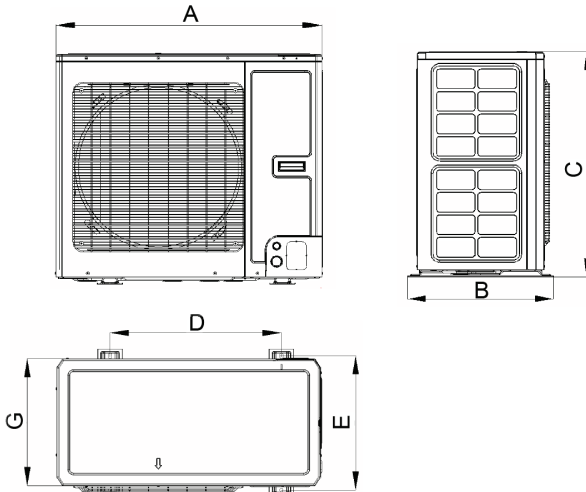

Unit: inch(mm)

Dimensions Model	A	B	C	D	E	G
CS18HV24A36	37 (940)	20-7/8 (530)	32-1/4 (820)	24 (610)	19-1/8 (486)	18-1/8 (460)

CS18HV48A60

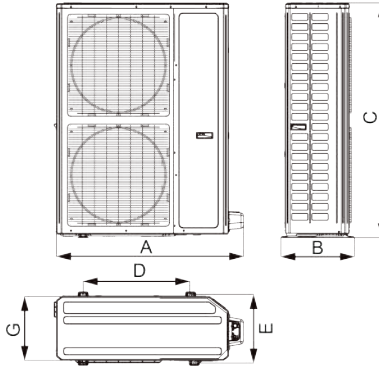

Unit: inch(mm)

Dimensions Model	A	B	C	D	E	G
CS18HV48A60	42-3/4 (1085)	16-7/8 (427)	53-3/4 (1365)	24-1/2 (620)	15-1/2 (395)	14-1/2 (370)

3.1.3 Diagram of Unit Installation Space and Location

Diagram of installation space and location for outdoor unit (Notice: for best performance of the outdoor unit, make sure its installation space conforms to the following installation dimensions).

1) When one outdoor unit is to be installed.

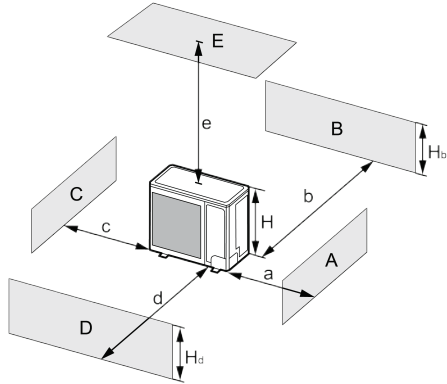

A~E	H _b	H _d	H	(mm)				
				a	b	c	d	e
B	—	—	—	-	≥100	-	-	-
A,B,C,	—	—	—	≥300	≥100	≥100	-	-
B,E	—	—	—	-	≥100	-	-	≥1000
A,B,C,E	—	—	—	≥300	≥150	≥150	-	≥1000
D	—	—	—	-	-	-	≥1000	-
D,E	—	—	—	-	-	-	≥1000	≥1000
B,D	H _b < H _d	H _d > H	—	-	≥100	-	≥1000	-
	H _b > H _d	H _d < H	—	-	≥100	-	≥1000	-
B,D,E	H _b < H _d	H _d ≤ 1/2H	—	-	≥250	-	≥2000	≥1000
		1/2H < H _d ≤ H	—	-	≥250	-	≥2000	≥1000
		H _b > H	Prohibited					
	H _b > H _d	H _d ≤ 1/2H	—	-	≥100	-	≥2000	≥1000
		1/2H < H _d ≤ H	—	-	≥200	-	≥2000	≥1000
		H _d > H	Prohibited					

2) When two or more outdoor units are to be installed side by side.

Unit: mm

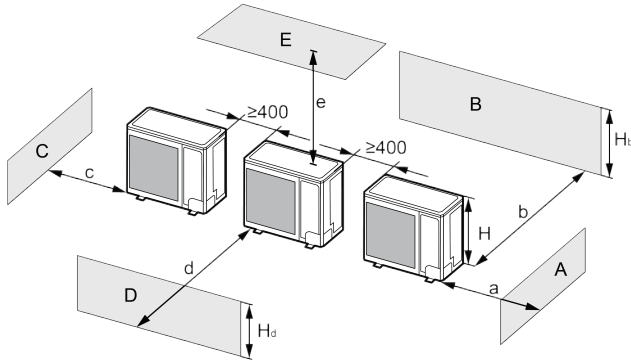

A~E	H _b H _d H		(mm)				
			a	b	c	d	e
A,B,C	—		≥ 300	≥ 300	≥ 1000	-	-
A,B,C,E	—		≥ 300	≥ 300	≥ 1000	-	≥ 1000
D	—		-	-	-	≥ 2000	-
D,E	—		-	-	-	≥ 2000	≥ 1000
B,D	H _b < H _d	H _d > H	-	≥ 300	-	≥ 2000	-
	H _b > H _d	H _d \leq 1/2H	-	≥ 250	-	≥ 2000	-
1/2H < H _d \leq H		-	≥ 300	-	≥ 2500	-	
B,D,E	H _b < H _d	H _b \leq 1/2H	-	≥ 300	-	≥ 2000	≥ 1000
		1/2H < H _b \leq H	-	≥ 300	-	≥ 2500	≥ 1000
		H _b > H	Prohibited				
	H _b > H _d	H _d \leq 1/2H	-	≥ 250	-	≥ 2500	≥ 1000
		1/2H < H _d \leq H	-	≥ 300	-	≥ 2500	≥ 1000
		H _d > H	Prohibited				

3) When outdoor units are installed in rows.

Unit: mm

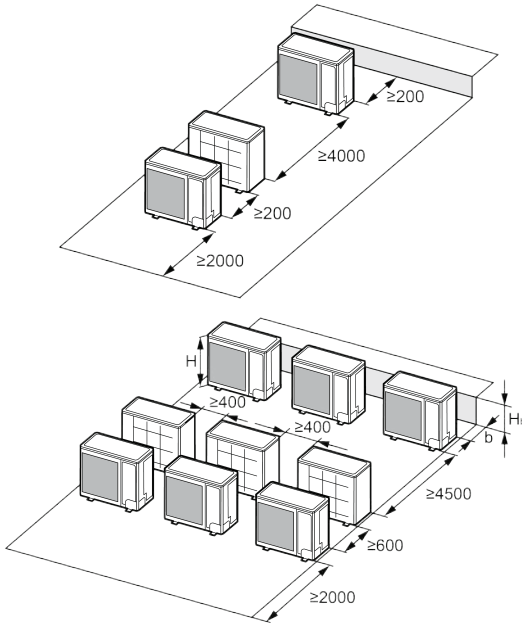

H_b H	(mm)
$H_b \leq 1/2H$	$b \geq 250$
$1/2H < H_b \leq H$	$b \geq 300$
$H_b > H$	Prohibited

4) When outdoor units are installed one above another.

Unit: mm

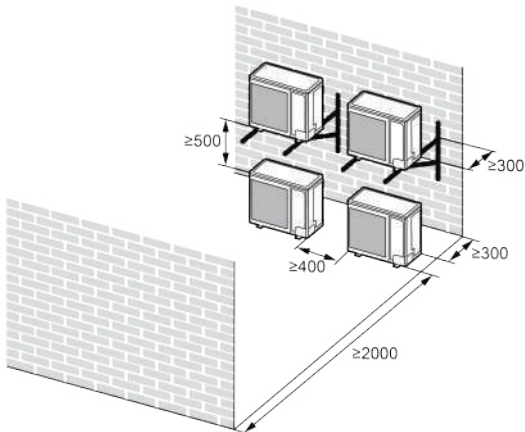

3.2 Unit Installation

NOTICE

The outdoor unit does not have a TXV (thermal expansion valve), please make sure there is a throttling valve (which throttles the unit when it operates in cooling mode and opens fully when it operates in heating mode) in the indoor unit (air handler or A coil).

3.2.1 Outdoor Unit Installation

- (1) If the outdoor unit is installed on a solid ground such as concrete, use M10 screw bolts and nuts to secure the unit and make sure the unit stands erect and level.
- (2) If it vibrates and causes noise, please add rubber cushion between the outdoor unit and the installation base.
- (3) When the outdoor unit is in heating or defrosting, it needs to drain water. When installing the drain pipe, plug the accompanied drainage connector to the drainage hole on the chassis of the outdoor unit. Then connect a drain hose to the drainage connector (If drainage connector is used, the outdoor unit should be at least 10cm from the installation ground. See the following figures).
- (4) Plugs and drainage connector are not recommended if there is an electrical heater on the chassis.
- (5) For areas with frequent snowfall, please clean up the snow in time to avoid covering unit.
- (6) The unit installed in areas expecting snow are suggested to be raised with support frames
- (7) If possible, avoid locations that are likely to accumulate snow. if not possible, a snow guard should be installed on the unit to prevent accumulation of snow on the top of the unit.

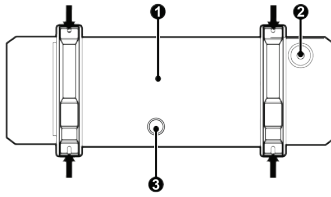

- ❶ Bottom
- ❷ Drain cap
- ❸ Drain pipe mounting hole

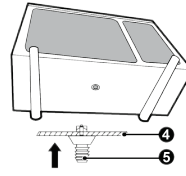

- ❹ Chassis
- ❺ Drain connection

3.2.2 Connection Pipe Installation

3.2.2.1 Installation Notice and Requirement on Connection Pipe

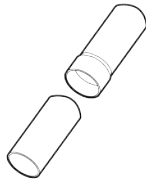

Line set size matches service valve connector



Do not crimp service valve connector when pipe is smaller than connector

Installation method: Connect the connection pipes first to the unit. When bending a connection pipe, be careful not to damage the pipe. Do not over-tighten the screw nut, otherwise leakage will occur. Besides, the outside of connection pipe should be added with a layer of insulating cotton to protect it from mechanical damage during installation, maintenance and transportation.

Model \ Item	Size of fitting pipe(inch)		Maximum pipe length feet(m)	Biggest drop between indoor and outdoor units feet(m)
	Liquid pipe	Gas pipe		
CS18HV24A36 CS18HV48A60	Φ3/8	Φ3/4	98.4(30)	49.2(15)

Connection pipe should adopt water-proof insulating material. Its wall thickness should be 0.5-1.0mm and the pipe wall should be able to withstand 6.0MPa. The longer the connection pipe is the worse cooling and heating performance it has.

3.2.2.2 Pipe Flaring

- (1) Cut the connection pipe with a pipe cutter.
- (2) The mouth of connection pipe should face downward. Remove burrs with the cut surface so that the chips do not enter the pipe.

- (3) Remove the cut-off valve of outdoor unit and take out the flare nut from the bag of indoor unit accessories. Then fit the flare nut on the pipe and use a flaring tool to flare the mouth of connection pipe.
- (4) Check whether the flaring part has cracked. (See the figure below).

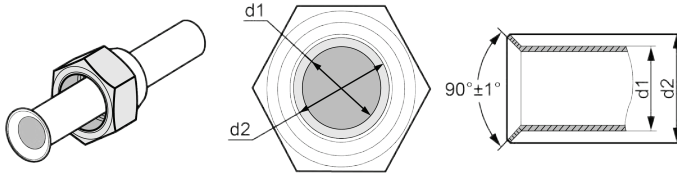

3.2.2.3 Pipe Bending

- (1) The pipes are shaped by your hands. Be careful not to collapse them.

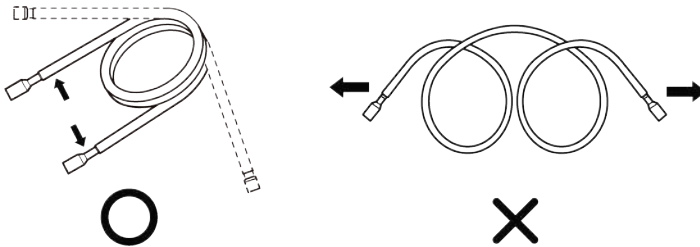

- (2) Do not bend the pipes in an angle more than 90°.
- (3) If the pipe is repeatedly bent or extended, it will become hard and difficult to be bent or extended. So do not bend or extend the pipe for more than 3 times.

- (4) When bending the pipe, do not bend it excessively, otherwise it will get broken. As shown beside, use a sharp cutter to cut the heat insulating pipe and bend it after the pipe is exposed. After bending, place the heat insulating pipe back on the pipeline and fix it with adhesive tape.

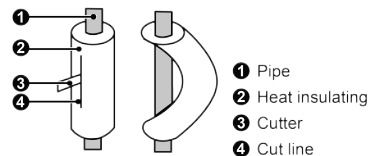

3.2.2.4 Connection Pipe of the Units

NOTICE	
①.	Connect the pipe to the unit. Please follow the instructions stated in the figures below. Use both spanner and torque wrench.
②.	When connecting the tapered screw nut, first apply chilled machine oil on its inner and outer surface and then screw it up for 3~4 circles.
③.	Confirm the tightening torque by referring to the following table (If the screw nut is over-twisted, it may be damaged and cause leakage).
④.	Check whether gas leakage occurs to the connection pipe and then apply thermal insulation, as shown below.
⑤.	Wind sponge around the joint of gas pipe and heat insulation sheath of gas collecting pipe.
⑥.	Be sure to connect gas pipe after liquid pipe is connected.
⑦.	Be sure to have insulation for gas pipe. Insulation for liquid pipe is optional.

3.2.2.4.1 Solder Connection

Screw on the flare nut of the flaring connecting pipe on the outdoor unit valve.

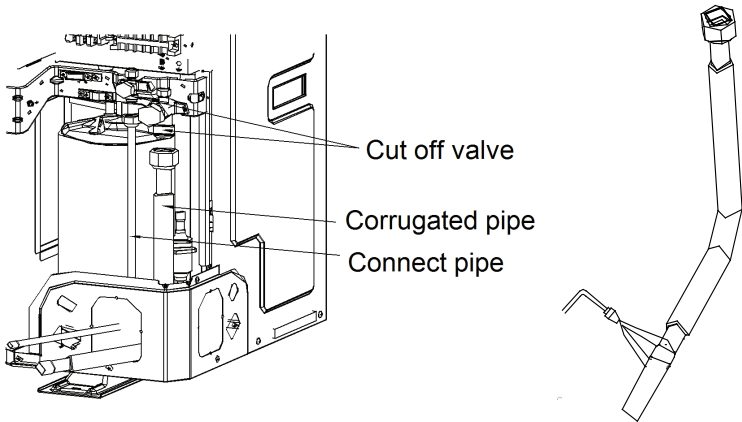

3.2.2.4.2 Screw Connection

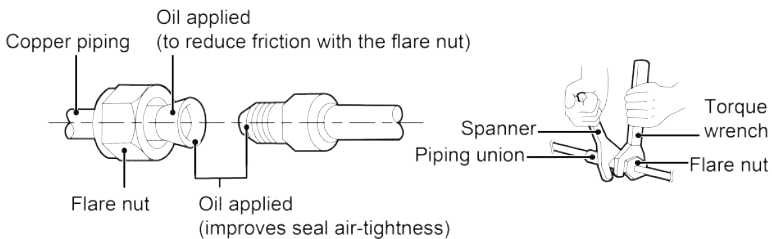

Pipe diameter (inch)	Tightening torque (N·m)
Φ1/4	15-30
Φ3/8	35-40
Φ1/2	45-50
Φ5/8	60-65
Φ3/4	70-75
Φ7/8	80-85

3.2.2.5 Sealing of the Knock-off Hole

As for the built-in valve model, during the installation process for connection pipe, when the connection pipe is passing through the knock-off hole, conduct sealing with insulated cotton in the knock-off hole of outdoor unit to prevent small animals from entering. See the following figures.

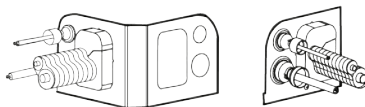

3.2.3 Connection Pipe Vacuum Pumping and Leak Detection

3.2.3.1 Vacuum Pumping

NOTICE

- | |
|--|
| ① Make sure the outlet of vacuum pump is away from fire source and is well-ventilated. |
| ② Before vacuum pumping, make sure the unit cut-off valves are closed. |
| ③ When vacuum pumping, both the liquid pipe and the gas pipe must be pumped. |

- (1) Remove the caps of the liquid valve, gas valve and also the service port.
- (2) Connect the hoses at the low pressure and high pressure sides of the manifold valve assembly to the service ports of the unit's gas valve and liquid valve, and meanwhile the gas and liquid valves should be kept closed in case of refrigerant leak.
- (3) Connect the hose used for evacuation to the vacuum pump.
- (4) Open the switch at the low pressure and high pressure side of the manifold valve at the same time, assembly and start the vacuum pump.

- (5) The evacuation duration depends on the unit's capacity, generally.

Model	Time(min)
CS18HV24A36	30
CS18HV48A60	45

And verify if the pressure gauge at the low pressure side of the manifold valve assembly reads -0.1MPa , if not, it indicates there is leak somewhere. Then, close the switch fully and then stop the vacuum pump.

- (6) Wait for 10min to see if the system pressure can remain unchanged. During this time, the reading of the pressure gauge at the low pressure side can not be larger than 0.005MPa .
- (7) Slightly open the liquid valve and let some refrigerant go to the connection pipe to balance the pressure inside and outside of the connection pipe, so that air will not come into the connection pipe when removing the hose. Note that the gas and liquid valve can be opened fully only after the manifold valve assembly is removed.
- (8) Place back the caps of the liquid valve, gas valve and also the service port.

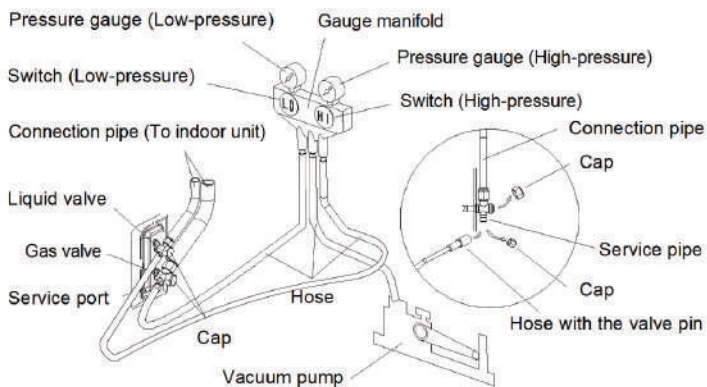

NOTICE

For large-size units, there are maintenance ports for liquid valve and gas valve. During evacuation, you may connect the two hoses of the branch valve assembly to the maintenance ports to speed up the evacuation.

3.2.4 Refrigerant Adding

See the following table for the amount of additional refrigerant.

Model \ Item	Standard pipe length	Unnecessary charge pipe length	Additional refrigerant amount for extra pipe
CS18HV24A36 CS18HV48A60	7.5m	≤9.5m	30g/m

3.2.5 Installation of Drain Pipe

3.2.5.1 Outdoor Side Drainage Pipe

- (1) If the outdoor unit is underneath the indoor unit, arrange the pipeline according to the following diagram.
 - 1) Drain hose should be placed on the ground and its end should not be immersed into water. The whole pipeline should be supported and fixed onto the wall.
 - 2) Wind the insulating tape from bottom to top.
 - 3) The whole pipeline should be wound with insulating tape and fixed onto the wall with saddles.

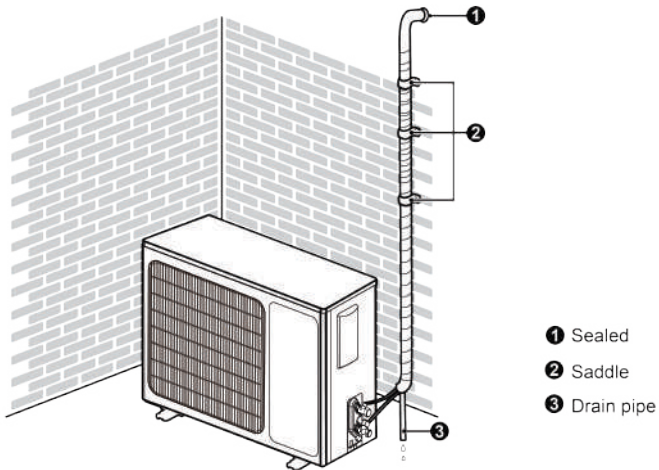

- (2) If the outdoor unit is above the indoor unit, arrange the pipeline according to the following diagram.
 - 1) Wind the insulating tape from bottom to top.

- 2) The whole pipeline should be wound together to avoid water returning to the room.
- 3) Use saddles to fix the whole pipeline onto the wall.

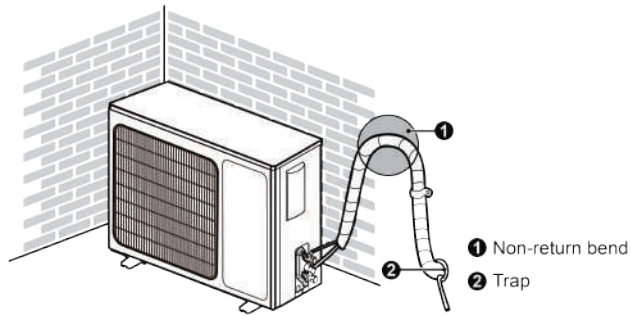

3.3 Electrical Installation

3.3.1 Requirement and Notice on Electrical Installation

⚠ WARNING

The electrical installation for the air conditioner should observe the following requirements:

- ①. The electrical installation must be conducted by professionals in compliance with local laws and regulations and the instructions in this manual. Never extend the power cords. The electric circuit must be equipped with a circuit breaker and air switch both with sufficient capacity.
- ②. The unit's operating power must be within the nominal range stated in the instruction manual. Use a specialized power circuit for the air conditioner. Do not draw power from another power circuit.
- ③. The air conditioner circuit should be at least 1.5m away from any inflammable surface.
- ④. The external power cords, the thermostat wires and outdoor unit must be effectively fixed.
- ⑤. The external power cords, the thermostat wires and outdoor unit can't directly contact any hot objects. For example: they must not contact chimney pipes, warm gas pipes or other hot objects.
- ⑥. The external power cords, and the thermostat wires and outdoor unit must not be squeezed. Never pull, stretch or bend the wires.

- ⑦. The external power cords, the thermostat wires and outdoor unit must not collide with any metal beam or edge on the ceiling, or touch any metal burrs or sharp metal edge around.
- ⑧. Connect wires correspondingly by referring to the circuit diagram labeled on the unit or electric box. Screws must be tightened up. Slipped screws must be replaced by specialized flat-head screws.
- ⑨. Wiring terminals should be connected firmly to the terminal board. Loose connection is forbidden.
- ⑩. The wire gauge of power cords should be large enough. Damaged power cords or other wires must be replaced by specialized wires. Wiring work must be done according to national wiring rules and regulations.
- ⑪. This outdoor unit has a heating four-way valve.

3.3.2 Electrical Parameters

Model	Power supply	Fuse capacity (A)	Maximum over-current protection (A)	Minimum circuit ampacity (A)
CS18HV24A36	208/230V-1Ph-60Hz	35	35	24
CS18HV48A60	208/230V-1Ph-60Hz	45	45	35

3.3.3 Connection of Power Cords and Thermostat Wires

- (1) For solid wires (as shown below):
 - 1) Use wire cutters to cut off the wire end and then peel away about 25mm of the insulation layer.
 - 2) Use a screwdriver to unscrew the terminal screw on the terminal board.
 - 3) Use nippers to bend the solid wire into a ring that fits the terminal screw.
 - 4) Form a proper ring and then put it on the terminal board. Use a screwdriver to tighten up the terminal screw.
- (2) For strand wires (as shown below):
 - 1) Use wire cutters to cut off the wire end and then peel away about 10mm of the insulation layer.
 - 2) Use a screwdriver to unscrew the terminal screw on the terminal board.

- 3) Use a round terminal fastener or clamp to fix the round terminal firmly on the peeled wire end.
- 4) Locate the round terminal conduit. Use a screwdriver to replace it and tighten up the terminal screw (as shown below).

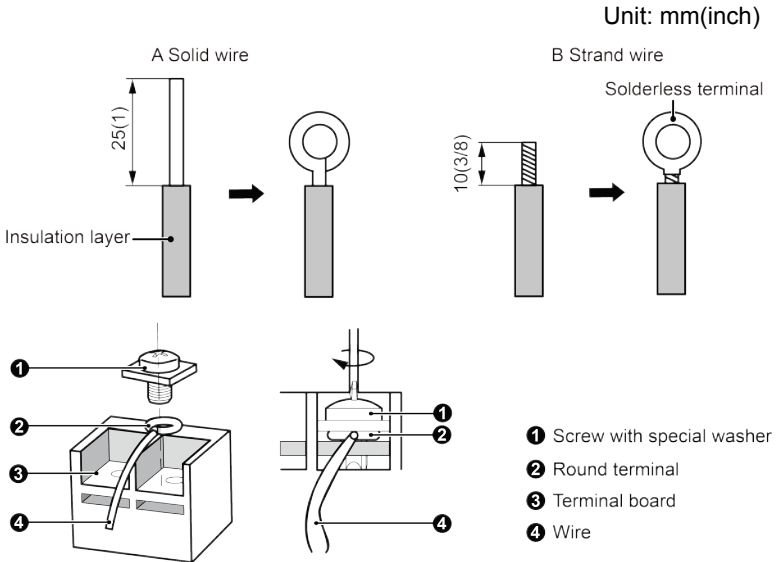

(3) How to connect the thermostat wires and power cords.

Lead the thermostat wires and power cords through the insulation tube (as shown in the following figure).

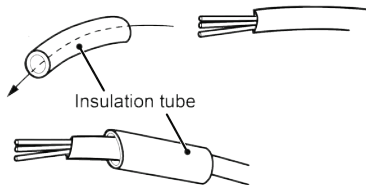

⚠ WARNING

- | |
|---|
| ①. Before working, please check whether the units are powered on. |
| ②. Wrong wire connection may burn the electrical components. |
| ③. Connect the wires firmly to the wiring box. Incomplete installation may lead to fire hazard. |
| ④. Ground wire should be connected. |

Wires of outdoor units

Single-phase unit: CS18HV24A36, CS18HV48A60

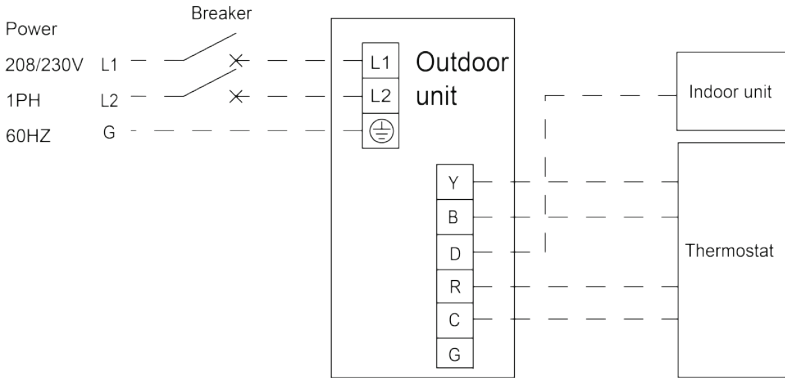

NOTE: Y means Compressor control signal;

B which is energized under the heating mode means 4-way valve control signal;

D means defrosting signal;

R means 24V AC power supply;

C means 24V common.

NOTE: When outdoor defrosts, D of outdoor unit will send 24V signal to avoid cold winds.

NOTE: As for the indoor unit which do not include D, there is no need to connect the D terminals.

⚠ WARNING

- ①. High and low voltage wires should be led through different rubber rings of the front plate.
- ②. Do not bundle up the thermostat wires or lay them side by side, otherwise errors will occur.
- ③. High and low voltage wires should be secured separately.
- ④. Use screws to tighten up the thermostat wires and power cords of the units on the terminal board. Wrong connection may lead to fire hazard.
- ⑤. If the thermostat wires of the units and power cords are not correctly connected, the air conditioner may get damaged.
- ⑥. Ground the units through connecting the ground wire.
- ⑦. The units should comply with applicable local and national rules and regulations on power consumption.

⚠ WARNING

- ⑧. When connecting the power cords, make sure the phase sequence of the power supply matches with the corresponding terminals, otherwise the compressor will get reversed and operate abnormally.

Remove the big handle/front panel of the outdoor unit and insert one end of the thermostat cord and the power cord to the terminal board.

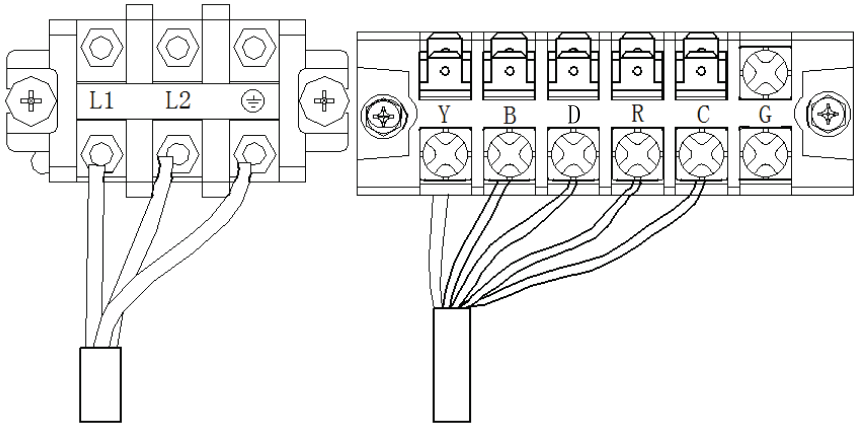

Single-phase unit: CS18HV24A36

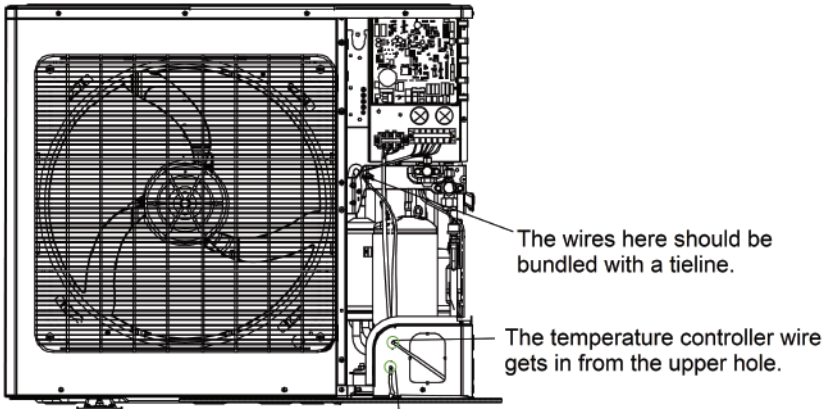

The power cords of outdoor unit get in from the lower hole.

Single-phase unit: CS18HV48A60

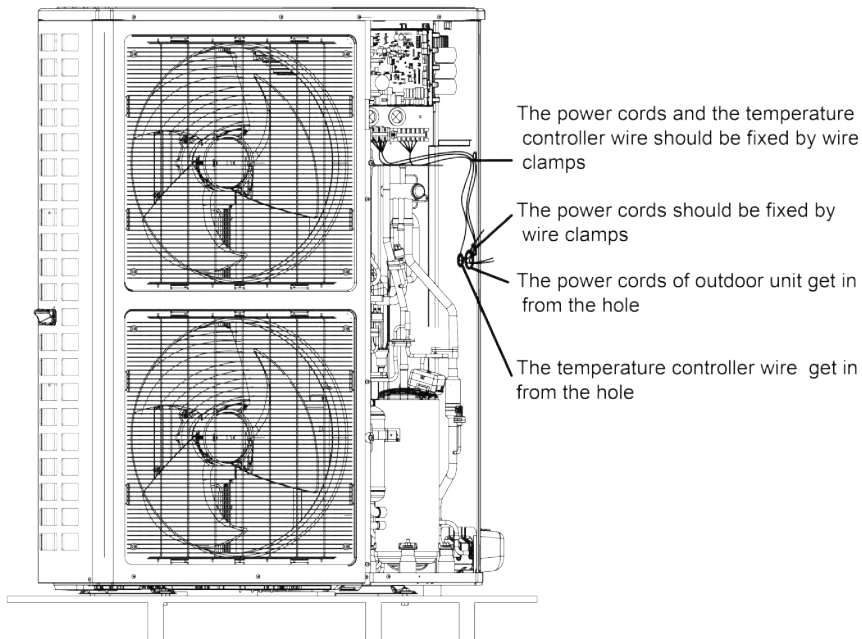

3.4 Check after Installation

Check Items after Installation

Check items	Possible events due to improper installation
Is the main body installed securely?	The unit may fall down, vibrate or produce noise.
Did you do water leakage test?	Cooling capacity may become unsatisfactory.
Is the unit well insulated from heat?	Condensate, water drops may occur.
Does water drainage go well?	Condensate, water drops may occur.
Is the voltage consistent with that stated on the nameplate?	The unit may fail or its components may get burned.
Are the wires and pipes installed correctly?	The unit may fail or its components may get burned.
Has the unit been safely grounded?	Risk of electric leakage.

Check items	Possible events due to improper installation
Do the specifications of wires comply with the requirement?	The unit may fail or its components may get burned.
Is there any obstacle blocking the air inlet and outlet of the units?	Cooling capacity may become unsatisfactory.
Have you recorded the length of refrigerant pipe and the refrigerant charging amount?	The refrigerant charging amount can't be controlled.

3.5 Test Running

Preparation before connecting the power:

- (1) Power must not be connected if the installation work is not completed.
- (2) Control circuit is correct and all the wires are firmly connected.
- (3) Cut-off valves of the gas pipe and liquid pipe are open.
- (4) The inside of the unit should be clean. Take irrelevant objects out if there is any.
- (5) After checking, re-install the front side plate.

Operation after connecting the power:

- (1) If all the above works are finished, power on the unit.
- (2) If the outside temperature is more than 30°C, heating mode can't be enabled.
- (3) Before test operation, make sure unit is power on and compressor has been preheated for more than 8 hours. Touch the unit to check whether it's normally preheated. Start test operation after unit is normally preheated, otherwise compressor might be damaged. Debugging must be performed by professional technicians or under the guide of professional technicians.
- (4) Make sure the units can run normally.
- (5) If there's sound of liquid shock when the compressor is running, then stop the air conditioner immediately. Wait until the electric heating belt is heated enough, and then restart the air conditioner.

NOTICE

- ① If you use thermostat to turn off the unit and then immediately turn the unit on again, compressor will need 3min to restart. Even if you press "ON/OFF" button on the thermostat, it won't be started up right away.

- ②. If there's no display on the thermostat, it's probably because the connection wires between the units and the thermostat are not connected. Please check again.

4 Maintenance

4.1 Failures Not Caused by Faults of the AC

If your air conditioner fails to function normally, please first check the following items before maintenance:

Problem	Cause	Corrective measure
The air conditioner can't run.	If you turn off the unit and then immediately turn it on, in order to protect the compressor and avoid system overload, compressor will delay running for 3min.	Please wait for a while.
	Wire connection is wrong.	Connect wires according to the wiring diagram.
	Fuse or circuit breaker is broken.	Replace the fuse or switch on the circuit breaker.
	Power failure.	Restart after power is resumed.
	Power plug is loose.	Re-insert the power plug.
Bad cooling or heating effect.	Air inlet and outlet of the units have been blocked.	Clear the obstacles and keep the room for the units well ventilated.
	Improper temperature setting	Reset a proper temperature.
	Fan speed is too low.	Reset a proper fan speed.
	Air flow direction is not right.	Change the direction of air louvers.
	Doors or windows are open.	Close them.
	Exposed under direct sunshine.	Put on curtains or louvers in front of the windows.
	Too many heat sources in the room.	Remove unnecessary heat sources.
	Filter is blocked or dirty.	Send for a professional to clean the filter.
	Air inlets or outlets of the units are blocked.	Clear away obstacles that are blocking the air inlets and outlets of the units.

The following situations are not operation failures.

Problem	Time of occurrence	Cause
Mist comes from the air conditioner.	During operation.	If the unit is running under high humidity, the wet air in the room will be quickly cooled down.
The air conditioner generates some noise.	System switches to heating mode after defrosting.	Defrosting process will generate some water, which will turn to water vapor.
	The air conditioner is buzzing at the beginning of operation.	Thermostat will be buzzing when it starts working. The noise will become weak 1min later.
Dust comes from the air conditioner.	When the unit is turned on, it purrs.	When the system is just started, the refrigerant is not stable. About 30s later, the purr of the unit becomes low.
	About 20s after the unit first enables the heating mode or there is refrigerant brushing sound when defrosting under heating.	It's the sound of 4-way valve switching direction. The sound will disappear after the valve changes its direction.
	There is hissing sound when the unit is started or stopped and a slight hissing sound during and after operation.	It's the sound of gaseous refrigerant that stops flowing and the sound of drainage system.
	There is a sound of crunching during and after operation.	Because of temperature change, front panel and other components may be swelled up and cause abrasion sound.
	There is a hissing sound when the unit is turned on or suddenly stopped during operation or after defrosting.	Because refrigerant suddenly stops flowing or changes the flow direction.
	The unit starts operation after being unused for a long time.	Dust inside the units come out together with the air.

Problem	Time of occurrence	Cause
The air conditioner generates some smell.	During operation.	The room smell or the smell of cigarette comes out through the units.

NOTICE

Check the above items and adopt the corresponding corrective measures. If the air conditioner continues to function poorly, please stop the air conditioner immediately and contact Continental's authorized local service center. Ask our professional service staff to check and repair the unit.

4.2 Error Code

 WARNING	
①.	If abnormal things (for example, awful smell) occur, please stop the unit immediately and disconnect power. Then contact Continental's authorized service center. If the unit continues to run in abnormal situations, it may get damaged and cause electric shock or fire hazard.
②.	Do not repair the air conditioner by yourself. Improper maintenance will cause electric shock or fire hazard. Please contact Continental's authorized service center and send for professional service staff to repair.

If the LED displayer on mainboard of outdoor unit displays an error code, please refer to the error code meaning stated in the following table.

No.	Error code	Error
1	E1	Compressor high-pressure protection
2	E3	Compressor low-pressure protection.
3	E4	Compressor air discharge high-temperature protection.
4	F2	Condenser temperature sensor error
5	F3	Outdoor ambient temperature sensor error
6	F4	Discharge temperature sensor error
7	F6	ODU tube temperature sensor error
8	EE	ODU memory chip error
9	H4	Overload
10	H5	IPM protection
11	H6	DC fan error
12	H7	Driver out-of-step protection
13	HC	PFC protection
14	Lc	Startup failure

No.	Error code	Error
15	P0	Driver reset protection
16	P5	Over-current protection
17	P6	Master control and driver communication error
18	P7	Driver module sensor error
19	P8	Driver module high temperature protection
20	PA	AC current protection
21	Pc	Driver current error
22	PL	Bus low-voltage protection
23	PH	Bus high-voltage protection
24	PU	Charge loop error
25	ee	Drive memory chip error
26	e1	High pressure sensor error
27	C4	ODU jumper cap error

4.3 Unit Maintenance

⚠ WARNING

- ①. Only professionals are allowed to carry on daily maintenance.
- ②. Before contacting any wire, make sure power is cut off.
- ③. Do not let any inflammable objects near the unit.
- ④. Do not use organic solvent to clean the air conditioner.
- ⑤. If you need to replace a component, please ask a professional to repair with a component supplied by the original manufacturer so as to ensure the unit's quality.
- ⑥. Improper operation may get the unit broken, hit by electric shock or cause fire.
- ⑦. Do not make the air conditioner wet or electric shock may be lead, ensure that the air conditioner will not be cleaned by water rinsing under any circumstance.

NOTICE

- ①. Before cleaning, please make sure the unit is stopped. Cut the circuit breaker and remove the power socket, otherwise, electric shock may occur.
- ②. Do not wash the air conditioner with water, otherwise fire hazard or electric shock may occur.
- ③. When cleaning the filter, please be careful of your steps. If you need to work high above the ground, please be extremely careful.

4.3.1 Heat Exchanger of Outdoor Unit

Conduct cleaning for the heat exchanger of outdoor unit periodically, clean it once at least in every two months. Clean the dust and sundries on the surface of the heat exchanger with dust collector and nylon brush, if there's compressed air source; use the compressed air to blow the dust on the surface of the heat exchanger. Don't use tap water for cleaning.

4.3.2 Drainage Pipe

Periodically check if the drainage pipe is blocked to smooth the condensate water.

4.3.3 Notices at the Beginning of the Using Season

- (1) Check if the air inlet/outlet of the units are blocked.
- (2) Check if the ground connection is reliable.
- (3) Check if the air filter screen is properly installed.
- (4) If starting up again after long-term shut down, preset the power switch of air conditioner to "ON" status before 8h of operation, to preheat the crankcase of outdoor compressor.
- (5) Check if the installation of outdoor unit is firm, if not, please contact with Continental appointed maintenance center.

4.3.4 Maintenance at the End of the Using Season

- (1) Cut off the main power of air conditioner.
- (2) Clean the dust and sundries in outdoor unit.
- (3) If the outdoor unit is rusty, coat the rusty location with paint to prevent it from expanding.

4.3.5 Components Replacement

Components are available in Continental agency or Continental distributors nearby.

4.4 Notice on Maintenance

4.4.1 Information on Servicing

The manual shall contain specific information for service personnel who shall be instructed to undertake the following when servicing an appliance that employs a flammable refrigerant.

4.4.1.1 General Work Area

All maintenance staff and others working in the local area shall be instructed on the nature of work being carried out. Work in confined spaces shall be avoided. The area around the workspace shall be sectioned off. Ensure that the conditions within the area have been made safe by control of flammable material.

4.4.1.2 Ventilated Area

Ensure that the area is in the open or that it is adequately ventilated before breaking into the system or conducting any hot work. A degree of ventilation shall continue during the period that the work is carried out. The ventilation should safely disperse any released refrigerant and preferably expel it externally into the atmosphere.

4.4.1.3 Checks to the Refrigeration Equipment

Where electrical components are being changed, they shall be fit for the purpose and to the correct specification. At all times the manufacturer's maintenance and service guidelines shall be followed. If in doubt consult the manufacturer's technical department for assistance.

The following checks shall be applied to installations using flammable refrigerants:

- (1) The ventilation machinery and outlets are operating adequately and are not obstructed.
- (2) If an indirect refrigerating circuit is being used, the secondary circuit shall be checked for the presence of refrigerant.
- (3) Marking to the equipment continues to be visible and legible. Markings and signs that are illegible shall be corrected.
- (4) Refrigeration pipe or components are installed in a position where they are unlikely to be exposed to any substance which may corrode refrigerant containing components, unless the components are constructed of materials which are inherently resistant to being corroded or are suitably protected against being so corroded.

4.4.1.4 Checks to electrical devices

Repair and maintenance to electrical components shall include initial safety checks and component inspection procedures. If a fault exists that could compromise safety, then no electrical supply shall be connected to the circuit until it is satisfactorily dealt with. If the fault cannot be corrected immediately but it is necessary to continue operation, an adequate temporary solution shall be used. This shall be reported to the owner of the equipment so all parties are advised.

Initial safety checks shall include:

- (1) Those capacitors are discharged: this shall be done in a safe manner to avoid possibility of sparking.
- (2) That no live electrical components and wiring are exposed while charging, recovering or purging the system.
- (3) That there is continuity of earth bonding.

4.4.2 Repairs to Sealed Components

4.4.2.1 Electrical Safety

From the equipment being worked upon prior to any removal of sealed covers, etc. If it is absolutely necessary to have an electrical supply to equipment during servicing, then a permanently operating form of leak detection shall be located at the most critical point to warn of a potentially hazardous situation.

4.4.2.2 Particular Attention

Electrical components, the casing is not altered in such a way that the level of protection is affected. This shall include damage to cables, excessive number of connections, terminals not made to original specification, damage to seals, incorrect fitting of glands, etc.

Ensure that apparatus is mounted securely.

Ensure that seals or sealing materials have not degraded such that they no longer serve the purpose of preventing the ingress of flammable atmospheres. Replacement parts shall be in accordance with the manufacturer's specifications.

NOTICE

The use of silicon sealant may inhibit the effectiveness of some types of leak detection equipment. Intrinsically safe components do not have to be isolated prior to working on them.

4.4.3 Repair to Intrinsically Safe Components

Do not apply any permanent inductive or capacitance loads to the circuit without ensuring that this will not exceed the permissible voltage and current permitted for the equipment in use.

Intrinsically safe components are the only types that can be worked on while live in the presence of a flammable atmosphere. The test apparatus shall be at the correct rating.

Replace components only with parts specified by the manufacturer. Other parts may result in the ignition of refrigerant in the atmosphere from a leak.

4.4.4 Cabling

Check that cabling will not be subject to wear, corrosion, excessive pressure, vibration, sharp edges or any other adverse environmental effects. The check shall also take into account the effects of ageing or continual vibration from sources such as compressors or fans.

4.4.5 Charging Procedures

In addition to conventional charging procedures, the following requirements shall be followed.

- (1) Ensure that contamination of different refrigerants does not occur when using charging equipment. Hoses or lines shall be as short as possible to minimize the amount of refrigerant contained in them.
- (2) Cylinders shall be kept upright.
- (3) Ensure that the refrigeration system is earthed prior to charging the system with refrigerant.
- (4) Label the system when charging is complete (if not already).
- (5) Extreme care shall be taken not to overfill the refrigeration system.
- (6) Prior to recharging the system it shall be pressure tested with OFN. The system shall be leak tested on completion of charging but prior to commissioning. A follow up leak test shall be carried out prior to leaving the site.

4.4.6 Decommissioning

Before carrying out this procedure, it is essential that the technician is completely familiar with the equipment and all its detail. It is recommended good

practice that all refrigerants are recovered safely. Prior to the task being carried out, an oil and refrigerant sample shall be taken in case analysis is required prior to reuse of reclaimed refrigerant. It is essential that electrical power is available before the task is commenced:

- (1) Become familiar with the equipment and its operation.
- (2) Isolate system electrically.
- (3) Before attempting the procedure ensure that:
 - 1) Mechanical handling equipment is available, if required, for handling refrigerant cylinders.
 - 2) All personal protective equipment is available and being used correctly.
 - 3) The recovery process is supervised at all times by a competent person.
 - 4) Recovery equipment and cylinders conform to the appropriate standards.
- (4) Pump down refrigerant system, if possible.
- (5) If a vacuum is not possible, make a manifold so that refrigerant can be removed from various parts of the system.
- (6) Make sure that cylinder is situated on the scales before recovery takes place.
- (7) Start the recovery machine and operate in accordance with manufacturer's instructions.
- (8) Do not overfill cylinders. (No more than 80% volume liquid charge).
- (9) Do not exceed the maximum working pressure of the cylinder, even temporarily.
- (10) When the cylinders have been filled correctly and the process completed, make sure that the cylinders and the equipment are removed from site promptly and all isolation valves on the equipment are closed off.
- (11) Recovered refrigerant shall not be charged into another refrigeration system unless it has been cleaned and checked.

4.4.7 Labelling

Equipment shall be labelled stating that it has been decommissioned and emptied of refrigerant. The label shall be dated and signed.

4.4.8 Recovery

When removing refrigerant from a system, either for servicing or decommissioning, it is recommended good practice that all refrigerants are removed safely.

When transferring refrigerant into cylinders, ensure that only appropriate refrigerant recovery cylinders are employed. Ensure that the correct number of cylinders for holding the total system charge are available. All cylinders to be used are designated for the recovered refrigerant and labelled for that refrigerant (i.e. special cylinders for the recovery of refrigerant).

Cylinders shall be complete with pressure relief valve and associated shut-off valves in good working order.

In addition, a set of calibrated weighing scales shall be available and in good working order. Hoses shall be complete with leak-free disconnect couplings and in good condition. Before using the recovery machine, check that it is in satisfactory working order, has been properly maintained Consult manufacturer if in doubt.

The recovered refrigerant shall be returned to the refrigerant supplier in the correct recovery cylinder, and the relevant Waste Transfer Notice arranged. Do not mix refrigerants in recovery units and especially not in cylinders.

If compressors or compressor oils are to be removed, ensure that they have been evacuated to an acceptable level to make certain that flammable refrigerant does not remain within the lubricant. The evacuation process shall be carried out prior to returning the compressor to the suppliers. Only electric heating to the compressor body shall be employed to accelerate this process. When oil is drained from a system, it shall be carried out safely.

4.5 After-Sales Services

Please contact the local Continental Distributor for service issues.



24 Napoleon Road, Barrie, Ontario, Canada L4M 0G8
103 Miller Drive, Crittenden, Kentucky, USA 41030
7200 Trans Canada Highway, Montreal, Quebec, Canada H4T 1A3

Tel: 1-866-820-8686
CONTINENTALCOMFORT.COM



66139901463